

Complete Clean Compressed Air



German Engineering



Your Health is Our Priority

A Complete System for Worker Health Protection

SATA® air vision 5000: Breathing Equipment to Protect Your Health

Your employees deserve **absolute** safety by means of **clean air supplied from outside the spray booth.**

The SATA® air vision 5000 supplied air respirator puts the focus on effective health protection and lets you experience a whole new and comfortable way of breathing, due to a completely redesigned breathing air supply system. With its modern, ergonomic design, the hood can be adapted to fit almost any head shape, allowing the individual adjustment of its effective circumference, height and position.



SATA® air vision 5000
carbon regulator set

Includes SATA air vision 5000 hood, SATA air regulator belt, SATA air carbon regulator. Version with activated charcoal adsorber
Order No. 214718



SATA® air vision 5000
regulator set

Includes SATA air vision 5000 hood, SATA air regulator belt, SATA air regulator (no charcoal)
Order No. 1005603



SATA® air carbon
regulator set

Includes SATA air regulator belt, SATA air carbon regulator
Order No. 1000075



SATA® air
regulator set

Includes SATA air regulator belt, SATA air regulator (no charcoal)
Order No. 1000116

PRODUCT BENEFITS

- High breathing air quality: The air supply, independent of the ambient air, eliminates all potential risks for the painter by contaminated spray booth air.
- No inhalation resistance, very comfortable breathing
- High level of protection, suitable for prolonged application intervals
- Visor allows one-hand operation
- Non-reflecting view due to solvent-resistant special foil
- Little operating costs, quick pay-off of purchase costs
- Ergonomic design with a host of options for individual adaptations
- Soft-stream flow-optimized air distribution in the hood
- Safety gauge with green zone notifies user of adequate air pressure, to maintain a constant positive pressure inside the hood, which prevents overspray intrusion

- Large field of vision
- Reduced sound level: 64dB (like a conversation in 3' distance)
- Rigid bump cap for safer work conditions
- Replaceable visor foils allow unchanging clear view onto the workplace
- The SATA CCS Disks (Color Code System) allow to personalize hood, SATA air regulator and SATA air carbon regulator
- To be used in conjunction with a filter unit, the SATA filter 584 or 284 is recommended; air supply to be effected via approved breathing hose



NIOSH approval number TC-19C-0533



SATA® air regulator only

Can be swiveled and adjusted on belt unity by up to +/-45°. To be used with three stage filter unit Order No. 1000207



SATA® air carbon regulator only

Can be swiveled and adjusted on belt unit by up to +/-45°. To be used with two stage filter unit Order No. 1000182

Hose Part Numbers - see page back page

SATA® air regulator belt

Comfortably cushioned belt allowing the individual adaptation and upgrade for modules Order No. 1000223



SATA® air vision 5000 hood only

SATA air vision 5000 hood only with pressure gauge The ergonomic design with a host of options for individual adaptations and soft-stream flow-optimized air stream provides highest wearer comfort Order No. 1005596



Spare Parts for SATA® air vision 5000

210405	Visor Foil, 6 perforations, 5 pieces
210468	Visor Foil, 6 perforations, 20 pieces
215550	Visor Foil, 6 perforations, 50 pieces
215590	Visor Foil, 6 perforations, 100 pieces
210526	Visor Foil, 6 perforations, 1000 pieces
208280	Headband assembly
218206	Activated charcoal filter for SATA air carbon regulator
213728	Comfort band, 10 pieces
211912	Hygiene insert, 20 pieces
226746	Hood cloth, dark grey

Functional Scheme of Compressed Air-Supplied Breathing Protection

With three-stage filter unit and SATA® air vision 5000 air regulator set

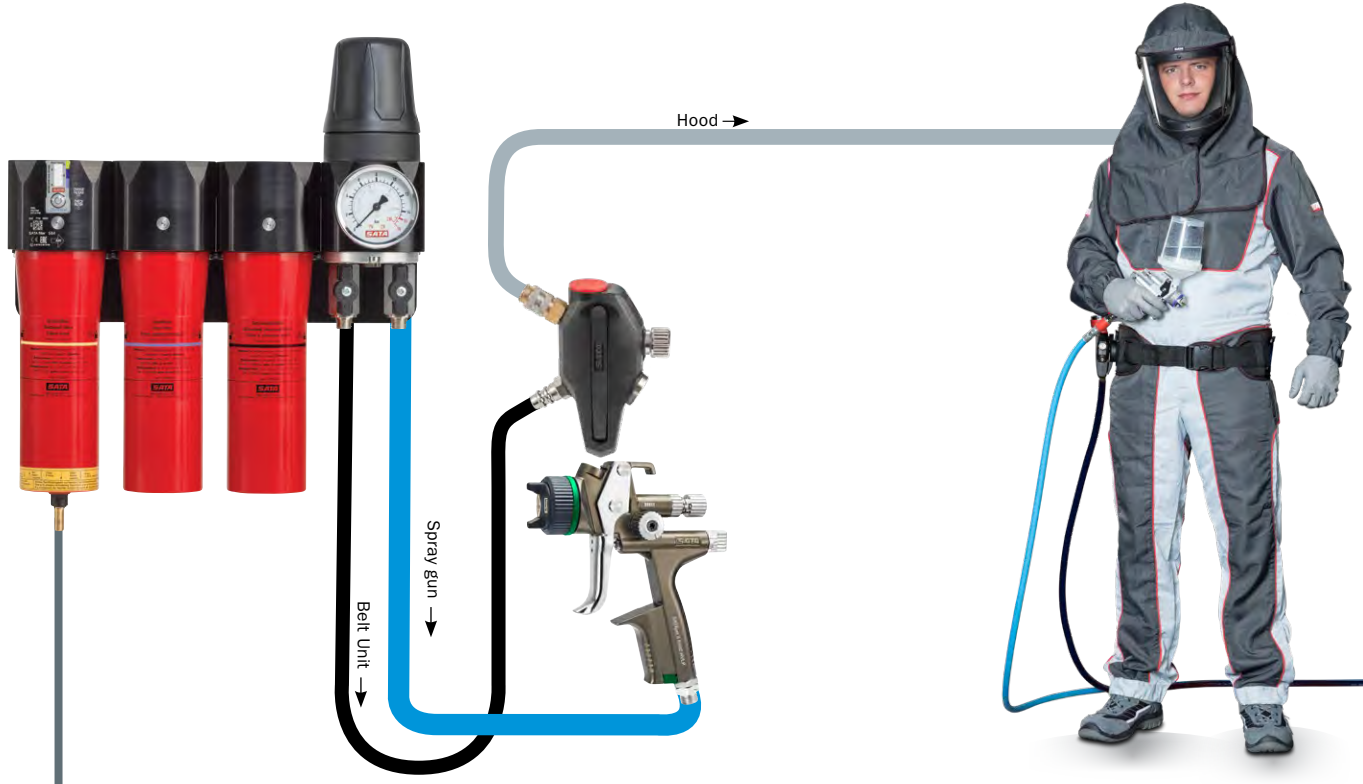

With two-stage filter unit and SATA® air vision 5000 carbon regulator set

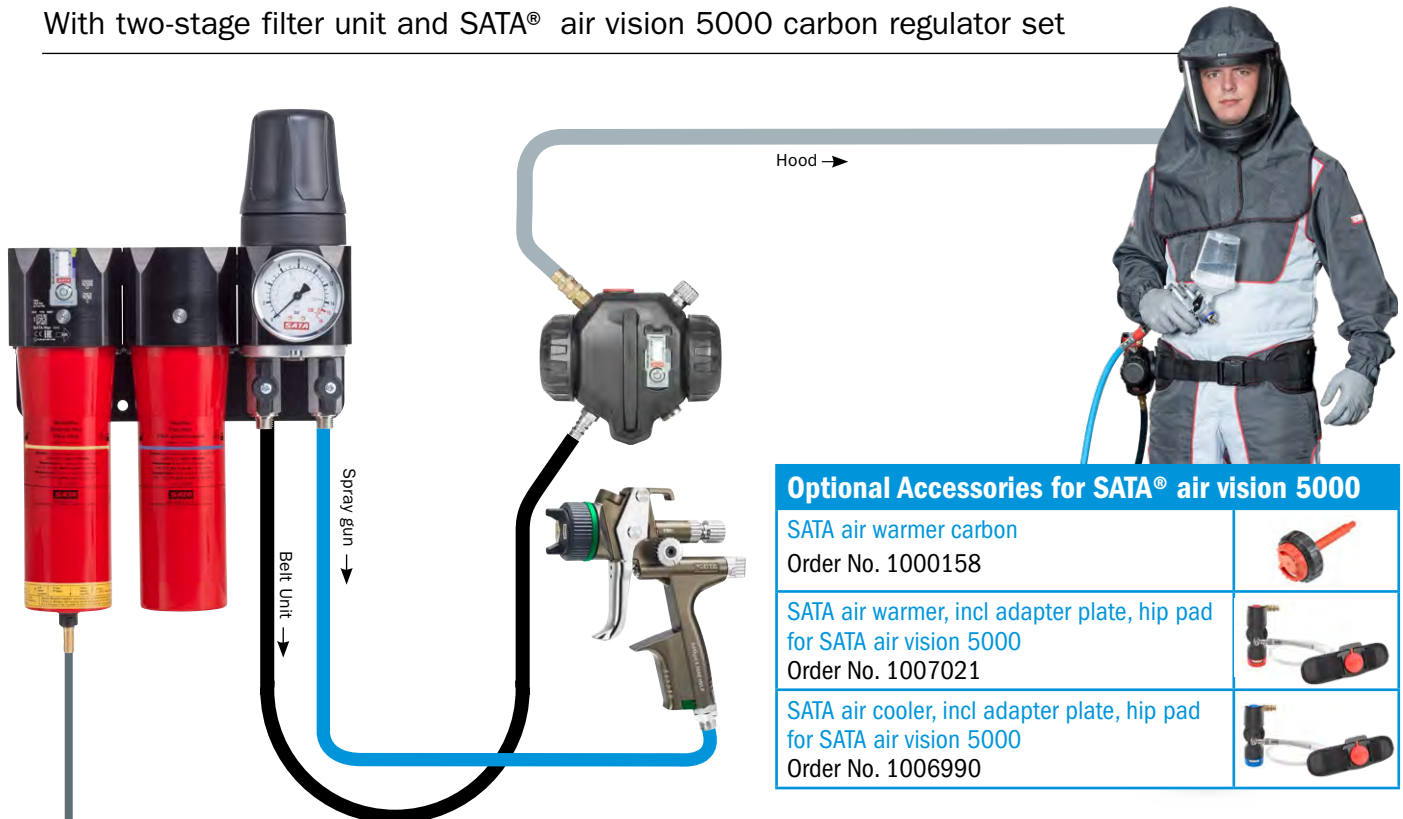

Optional Accessories for SATA® air vision 5000

SATA air warmer carbon
Order No. 1000158



SATA air warmer, incl adapter plate, hip pad
for SATA air vision 5000
Order No. 1007021



SATA air cooler, incl adapter plate, hip pad
for SATA air vision 5000
Order No. 1006990



Monitoring Air for Carbon Monoxide (CO)

Carbon monoxide is an odorless, colorless, highly poisonous gas caused by partial combustion. Combustion does not take place in a compressor. Yet an overheated compressor could convert lubricating oil to carbon monoxide, or contaminated air could be drawn into the compressor intake from an outside environment.

X288 SENTINEL

The Model X288 Carbon Monoxide (CO) Monitor and Alarm is a battery operated instrument that can be surface mounted on or near the outer wall of a paint booth or other position as close as possible to the air supply (within the temperature range of -4 F to 122 F). Recommended to mount in a highly visible area near entrance door to paint booth. Provided air supply hose and fittings allow to be connected to SATA filter/regulator with a 10' hose. It continuously monitors a compressed air sample connected to its sample inlet and it gives an alarm when: • The CO in the sample exceeds a preset level (adjustable, initially set at 10 PPM). It indicates CO concentration on a digital display

X767 GUARDIAN

The X767 is an AC powered Carbon Monoxide Monitor with LCD readout for larger shops or shops that require remote alarms. These monitors provide continuous digital indication of CO levels from 0 to 199 ppm and operate with the reliable Electrochemical sensor. The units give an audible (85db @ 3ft) and visual alarm at 10 ppm. Air sample tubing connects the monitor to the filter unit. The X767 monitor housing is fitted with RF filters to minimize interference from portable radios and cell phones. Optional remote alarms and horns are available.

CO Monitor Accessories

Over time the CO sensor becomes less sensitive with age making it necessary to re-calibrate the monitor. Calibration kits contain test gas, tubing with flow meter and regulator. Accessory alarm buzzers are available for shops that require sending an audible alarm to a remote location. Some installations may wish to mount the air horn alarm directly in the paint booth.

X288 Sentinel CO Monitor



The Model X288 Carbon Monoxide (CO) Monitor and Alarm is a battery-operated instrument that can be surface mounted on or near the outer wall of a paint booth, in visible area near entrance door. Indicates CO concentration on a digital display

Order No. X288

X767 Guardian CO Monitor



110 volt AC Carbon Monoxide Monitor Audible and visual alarms for high CO or sensor failure. LCD digital readout

Order No. X767-PLUS

Calibration Kit



Calibration kit for carbon monoxide monitor

To be used on all current CO monitors. The more often the instrument is calibrated, the more accurate the instrument is.

Order No. X81-1232K

Siren Alarm



Siren alarm with strobe light

For use with X767 only

Order No. XA166

Remote Alarm



Standard 85db remote alarm for CO monitor

Order No. XA176

Extra loud 100db remote alarm for CO Monitor

Order No. XA176A

For use with X767 only

Many options available - Please inquire

SATA® vision 2000 Breathing Equipment to Protect Your Health

SATA vision 2000 offers complete head and breathing air protection from solvent vapor and isocyanates. The single pane anti-static visor is non-glare and provides a wide field of vision. It's very comfortable to wear with an adjustable headband, tip-up visor and easily replaced hygienic linings. Air volume 6.2-11.3 cfm @ 60-90 psi.

SATA® vision 2000 hood only



Full hood respirator and full neck shield only
Order No. 51854

SATA® industrial belt valve



SATA industrial belt valve only is to be used in conjunction with a triple-stage filter
Order No. 61002 vision 2000
Order No. 138362 air star C

SATA® activated charcoal belt unit



SATA activated charcoal adsorber belt unit only is an auxiliary filter. Breathing air is filtered through activated charcoal. to be used in conjunction with a double-stage filter
Order No. 37200 vision 2000
Order No. 37192 air star C



vision 2000 hood w/charcoal filter
Order No. 36384



vision 2000 hood w/Ind. belt valve
Order No. 60707



SATA® vision™ 2000

The complete health protection system

Supplied-air respirator hood with choice of charcoal filter belt unit or the industrial belt unit.

Optional Accessories for SATA® vision 2000

Breathing air warmer

Infinitely adjustable breathing air warmer
Order No. 61242



Spare Parts for SATA® vision 2000

SATA vision 2000 sweat bands

Replacements for vision 2000
Natural Leather Order No. 61226
Artificial Leather Order No. 47571
10 pk Order No. 10330



SATA vision 2000 hood lining

Hygienic, 20 pk
Order No. 69658



SATA vision 2000 grey cape only

Hood/chest cloth, anti-static
Order No. 60541



35659	SATA vision 2000 tear-off sheets, 5 pk
35675	SATA vision 2000 tear-off sheets, 25 pk
35050	SATA vision 2000 tear-off sheets, 50 pk
35100	SATA vision 2000 tear-off sheets, 100 pk
36301	SATA vision 2000 tear-off sheets, 1000 pk

SATA® VISION 2000™

This respirator hood was especially designed to comply with painters' requirements protecting the respiratory system, eyes, skin and hair from harmful substances (especially important with waterborne paints).

NIOSH approval number TC-19C-211



Product Benefits

- High breathing air quality due to air supply independent of ambient air, no inhalation resistance, high breathing comfort
- High protection level, suitable for long application intervals
- Visor allows one-hand operation
- Non-reflecting view due to solvent-resistant foil
- Little operating costs, quick pay-off of purchase costs

Breathing systems which are **independent from ambient air** provide clean breathing air via a compressed air hose from an area outside of the workplace. Usually, this air is additionally cleaned using a filter system.



w/charcoal filter
Order No. 137547



w/Ind. belt valve
Order No. 137745



SATA® air star C™

The supplied-air half mask

Skin-friendly mask made of TPE* with anatomically shaped sealing frame, solvent-resistant.

- Safe seat, free field of vision (protective goggles Order No. 97485 required, not included in delivery)
- No accumulation of heat and humidity inside the mask

SATA® air star C



Respirator only with breathing tube
Order No. 137653

SATA® AIR STAR C®

NIOSH approved ventilated half-mask with adjustable continuous fresh-air supply with built in exhausting valve. The SATA air star C provides maximum view and a far better breathing protection than any filter mask, suitable for almost all head sizes for a perfect face fit with four-point fixed head straps for seating the mask safely. Please ensure protection of eyes, skin and hair during painting.

* Thermoplastic elastomer

Product Benefits

- Maximum vision (protective goggles required)
- High breathing air quality due to air supply independent of the ambient air, no inhalation resistance, no accumulation of heat and humidity inside the mask
- Excellent fit for any type of facial contours
- Very light and comfortable
- 4 pointed straps for easy handling and safe seal

NIOSH approval number TC-19C-210



SATA® Filter 500 Series – Professional Air Filtration

Compressed air is one of the main sources of energy in paint shops. After being generated in the compressor, the air is fed into the compressed air circuit, whereby impurities such as tiny particles of compressor oil can be carried along right into the spray gun or breathing air. While such impurities are not particularly relevant for many industrial applications, they will inevitably cause coating flaws or pose a health risk in the paint application process. When working with waterborne paint systems, even the tiniest quantities of oil vapors can cause coating flaws, and consequently time-consuming, costly rework. Oil vapors or particles may also enter the respiratory system and cause health issues.

The SATA filter series 500 is available either as a one-stage sintered filter with water and oil separator, as a two-stage combination filter with sintered and fine filter, or as a three-stage filter unit with additional sintered activated charcoal filter. Every six months, all filter stages are maintained together in a procedure that takes just a few minutes without the need for tools, thanks to the bayonet lock and defined position of the filter cartridges, which are replaced simply by inserting them. Furthermore, a flow-optimized cyclone separator minimizes pressure drop in the filter system and ensures a constant air flow of approximately 135 cfm.

A well functioning compressed air circuit also includes regularly maintained compressed air filter units. To warrant trouble-free operation, a filter unit should be fitted either immediately in front of or directly inside the spray booth. While the SATA filter 544 will be sufficient for solvent-based paints, the SATA filter 584 is required when applying waterborne paints, as the activated charcoal stage eliminates the critical oil vapors that can cause coating flaws with waterborne materials.

A three-stage SATA 584 filter unit is also needed when using a compressed air-fed respirator (without "belt-hung" activated charcoal filter) to clean the air of harmful substances.



SATA filter cover
for all SATA filters series 500, set of 4
Part Number 1101500

SATA® Filter 500 video links

Teaser	Functionality	Maintenance	Retrofit SATA filter 544 to SATA filter 584	Extension to 4 air outlets	Change air flow from right to left	Installation of SATA adam 2	In-depth Filter 500 by Dan-Am
							
SCAN ME	SCAN ME	SCAN ME	SCAN ME	SCAN ME	SCAN ME	SCAN ME	SCAN ME

PRODUCT BENEFITS

- Higher adsorption of contaminations (compared to SATA filter 484) due to the new sintered activated charcoal filter
- Air flow with approx. 135 cfm
- SATA filter timer to monitor the exchange intervals of all filter cartridges
- Synchronized maintenance: Filter maintenance only necessary every 6 months for all stages
- Bayonet lock with haptic and acoustic feedback
- Fine filter and activated charcoal filter cartridges fit perfectly, simply insert – without screw fittings or additional seals
- CCS color coding of filter housing and filter cartridges for safe maintenance.
- Upgrade of a SATA filter 544 to a 584 possible through a simple connector system
- Maintenance-free sealing elements
- Reverse air-flow options available
- Flow-optimized cyclone separator with enhanced particle separation efficiency of particles > 5 µm

SATA® Pressure reducer 520™ with pressure gauge



Air flow at 87 psi: 135 cfm
Ambient temperature: 248 °F
Connection:
 Air inlet: G 1/2" female thread
 Air outlet: G 1/2" female thread

Order No. 1101667

SATA® filter 564® | Single-stage activated charcoal filter



for retrofitting
 SATA filter 544

Filter fineness:
 Activated charcoal: adsorbes oil vapors from the compressed air
Air flow at 87 psi: 135 cfm
Ambient temperature: 140 °F
Connection:
 Air inlet: G 1/2" female thread
 Air outlet: G 1/2" female thread
For retrofitting SATA 544 filter to SATA 584 filter

Order No. 1101005

SATA® filter 524® | Single-stage sintered filter



Filter fineness:
 Sintered filter: 5 µm
Air flow at 87 psi: 135 cfm
Ambient temperature: 248 °F
Connection:
 Air inlet: G 1/2" female thread
 Air outlets: 1/4" male thread
Recommended for:
 Gun cleaning equipment | pre-filter in compressed air circuit

Order No. 1101659

SATA filter 500 – modular filter series for highest demands

The combination units SATA filter 544 and 584 are defining the standard in paint booths and breathing air treatment.

SATA® filter 584® | 3-stage combination filter



100% technically particle-free air
Filter fineness:
 Sintered filter: 5 µm | Fine filter: 0.01 µm
 Activated charcoal filter: oil vapors
Air flow at 87 psi: 135 cfm
Ambient temperature:
 248 °F; with activated charcoal filter up to 140 °F
Connection:
 Air inlet: G 1/2" female thread
 Air outlets: 1/4" male thread
Recommended for:
 solvent-based paints | waterborne | breathing protection equip.

Order No. 1099953

SATA® filter 584L® | 3-stage combination line-filter



100% technically particle-free air
Filter fineness:
 Sintered filter: 5 µm | Fine filter: 0.01 µm
 Activated charcoal filter: oil vapors
Air flow at 87 psi: 135 cfm
Ambient temperature:
 248 °F; with activated charcoal filter up to 140 °F
Connection:
 Air inlet: G 1/2" female thread
 Air outlet: G 1/2" female thread
Recommended for:
 solvent-based paints | waterborne | breathing protection equip.

Order No. 1101716

SATA® filter 544® | 2-stage combination filter



99.998% technically particle-free air
Filter fineness:
 Sintered filter: 5 µm | Fine filter: 0.01 µm
Air flow at 87 psi: 135 cfm
Ambient temperature: 248 °F
Connection:
 Air inlet: G 1/2" female thread
 Air outlets: 1/4" male thread
Recommended for:
 solvent-based paints | Breathing protection when also using charcoal belt unit

Order No. 1100990

SATA® filter 544L® | 2-stage combination line-filter



99.998% technically particle-free air
Filter fineness:
 Sintered filter: 5 µm | Fine filter: 0.01 µm
Air flow at 87 psi: 135 cfm
Ambient temperature: 248 °F
Connection:
 Air inlet: G 1/2" female thread
 Air outlet: G 1/2" female thread
Recommended for: solvent-based paints | Breathing protection when also using charcoal belt unit

Order No. 1124932

SATA filter 500 series – Compressed air treatment system

A well functioning compressed air circuit also includes regularly maintained compressed air filter units. To warrant trouble-free operation, a filter unit should be fitted either immediately in front of or directly inside the spray booth. While the SATA filter 544 will be sufficient for solvent-based paints, the SATA filter 584 is required when applying waterborne paints, as the activated charcoal stage eliminates the critical oil vapors that can cause coating flaws with waterborne materials.

A three-stage SATA 584 filter unit is also needed when using a compressed air-fed respirator (without "belt-hung" activated charcoal filter) to clean the air of harmful substances.

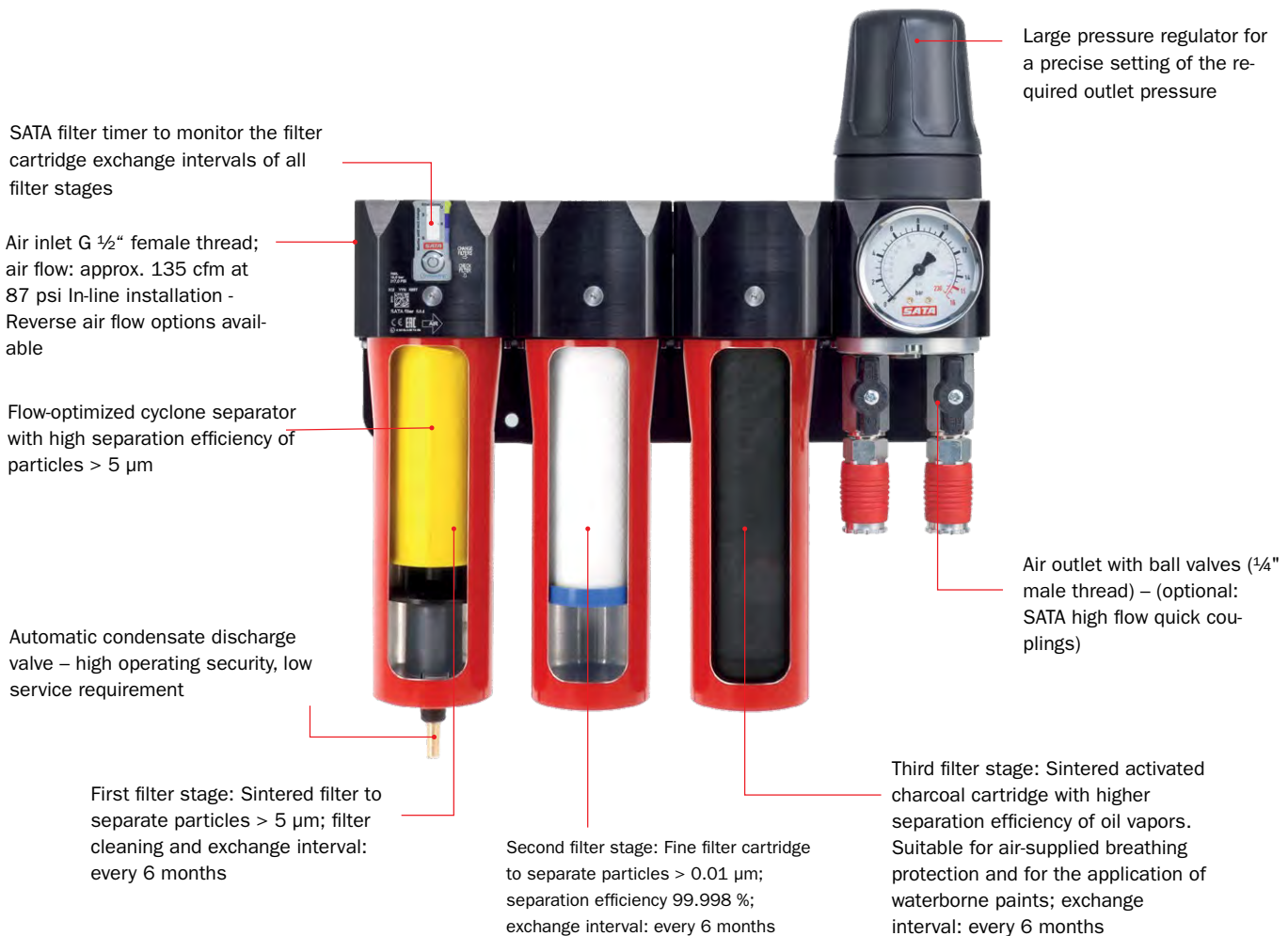

SATA filter cartridges

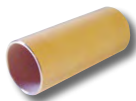

SATA Sintered Filter

Stage 1, sintered bronze filter eliminates particles > 5 µm
Order No. 22160



SATA Fine Filter

Stage 2, fine filter eliminates particles > 0.01 µm
Order No. 1097999



SATA Activated Charcoal Filter

Stage 3, sintered activated charcoal filter separates oil vapors
Order No. 1098004

Filter maintenance - ensuring premium air quality



In order to preserve its efficiency, the filter unit must be regularly maintained, thus avoiding coating flaws and other quality issues and eventually expensive rework.

To remind the user to exchange the filter cartridges on a regular basis, every filter unit is equipped with the SATA® filter timer.

Please note: Especially high contaminant content in the compressed air may require shorter exchange intervals

Handling the SATA® filter timer is as easy as that:

1. When a new filter regulator unit is installed, each filter timer must be activated by pressing the button.
2. Pressing this button "starts" the servicing interval of the respective filter stage. Over time, the display window will gradually turn to red, indicating the passing of time and serving as a guide to the measure of filter saturation with normal use.
3. Whenever a window has completely changed to red, the concerned filter cartridge needs to be replaced. In line with the two different recommended replacement intervals of approximately three (activated charcoal) or six months (fine and sintered filter) respectively, there will be two filter timer versions available.

Additionally, the exchange filter cartridges are also supplied with SATA® filter timers which have to be inserted in the self-adhesive cages on the filter canisters and activated once maintenance is completed.



SATA filter timer with 3 months (left) or 6 months (right) run-time, resp.



Release of the
SATA® filter timer

1.



The display window
will gradually turn to
red, indicating the
passing of time

2.



Once the display window
has completely changed
to red, the filter needs
to be replaced.

3.

SATA® Filter 200 Series – Professional Air Filtration for Small Shops

Along with the 500, the 200 filter series is the most versatile modular filter system currently on the market but at an unbeatable price. The 200 is rated at 72 cfm @ 90 psi, more than adequate for many small shops. Air flow is left to right, which can be converted if needed. When atomized air leaves the spray gun, it must be clean, dry and free of condensation, silicone, oil or any other contamination. Otherwise, the finished result can have a dull finish, fish eyes, water or dust. Clean, pure air is also a must for breathing air.

SATA® filter 284® | triple-stage in-line filter



100 % technically particle-free air

Filter fineness:
Sintered filter: 5 µm
Fine filter: 0.01 µm
Activated charcoal filter: oil vapours

Connection:
Air inlet: G 1/2" female thread
Air outlet: G 1/2" female thread,
Hi-flow coupling 1/4"

2 Drop Order No. 141218 | 4 Drop Order No. 141218-4

SATA® filter 234® | single-stage fine filter



Filter fineness:
In-line 0.01 micron filter unit. Provides 99.998% clean air. Compressed air must be pre-filtered when using this unit.

Connection:
Air inlet: G 1/2" female thread
Air outlet: G 1/2" female thread

Order No. 44434

SATA® filter 282® | triple-stage in-line filter



100% technically particle-free air

Filter fineness:
Sintered filter: 5 µm
Fine filter: 0.01 µm
Activated charcoal filter: oil vapours

Connection:
Air inlet: G 1/2" female thread
Air outlet: G 1/2" female thread

Order No. 189290

SATA® filter 264® | single-stage activated charcoal filter



Filter fineness:
Activated charcoal: adsorbes oil vapours from the compressed air

Connection:
Air inlet: G 1/2" female thread
Air outlet: G 1/2" female thread

Order No. 141226

SATA® filter 244® | double-stage filter



Filter fineness:
Sintered filter: 5 µm
Fine filter: 0.01 µm

Connection:
Air inlet: G 1/2" female thread
Air outlet: G 1/2" female thread,
Hi-flow coupling 1/4"

2 Drop Order No. 44404 | 4 Drop Order No. 44404-4

SATA® filter 242® | double-stage filter



Filter fineness:
Double-stage sinter filter/fine filter with pressure regulator for air installation (G 1/2 female thread). Use as an unregulated line filter for very fine particle separation

Connection:
Air inlet: G 1/2" female thread
Air outlet: G 1/2" female thread

Order No. 43752

SATA® filter 222® | single-stage sinter filter



Filter fineness:
Sinter filter with pressure gauge, automatic condensate discharger, use as an unregulated line filter
Sintered filter: 5 µm

Connection:
Air inlet: G 1/2" female thread
Air outlet: G 1/2" female thread

Order No. 43687

Poor material adherence, nibs and other coating flaws lead to time-consuming and expensive rework. Most coating flaws are the result of poor air quality which can be prevented with the installation of SATA® filter regulator units.

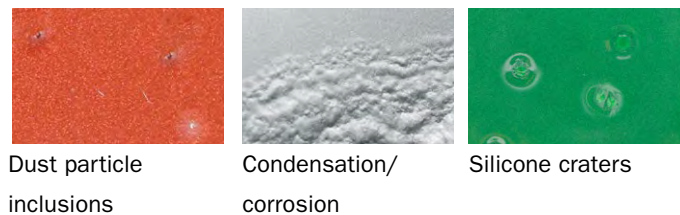

SATA Particle Filter
Stage 1, Sintered bronze filter
Order # 22160



Micro-Fine Fiber Filter
Stage 2, Micro-Fine filter
Order # 81810



SATA Activated Charcoal Filter
Stage 3, Activated charcoal filter
Order # 85373

Professional Aluminum Compressed Air Piping System

Today's clean air requirements are more critical than ever. Air tools, blow driers, HVLP spray guns, and supplied air respirators may require more air volume and better air quality than needed in the past. Not only does clean air effect equipment performance, but it is also critical for paint coatings performance. Dan-Am Air, along with SATA filtration can solve all of these issues.

Dan-Am Air is lightweight, aircraft grade aluminum, QUALICOAT certified surface finish, which provides clean, dry air up to 232 psi. The reinforced composite Nylon fittings have dual seals, which rest on un-scraped pipe, providing a leak free guarantee. Our Press-to-Connect fittings feature a full bore design for turbulence free air delivery. This quick, instant connection eliminates the need to thread, solder or glue, accounting for far less installation times. Unlike the performance of steel and copper, which degrades over time due to corrosion, DanAm Air provides clean air quality with optimum flow rate performance.

- Energy efficient
- Easy to install
- Modular design
- Corrosion resistant
- Leak-free guarantee
- Removable and reusable
- Push-to-connect technology
- Immediate pressurization
- Full bore design
- 1/2" to 6" pipe sizes



Product design and support is readily available from SATA USA Inc. As well as in-house support for quotes and general information.

DanAmAir[®]

Check the savings chart at www.DanAmAir.com
For a FREE quote call: 800-533-8016

Air compressor, refrigerant dryer and storage tank

The safety professional or business manager faced with providing clean compressed air for the needs of today's body shop may find information complex and inconsistent. The most important and confusing area is defining the capacity and duty cycle to prevent compressor damage. Consulting with the compressor supplier is usually the best solution to establish air volume requirements. Usually a low-pressure (150 psi) compressor is utilized in the majority of body shops and many other industrial manufacturing firms.

Air compressors are normally of the reciprocating or axial screw type. Either type can provide safe, clean breathable air quality when properly located, filtered and monitored. Choosing the location of the compressor that supplies the breathing air system is crucial. If intake air is clean and free of toxic gases the remainder of the system should not cause any special problem. However, if the compressor air intake is located inside a manufacturing plant, on the roof in proximity to vents and exhausts, or through a wall into an environment of auto exhaust, or within any toxic environment, there is virtually no chance that the system will function satisfactorily. Badly worn compressors often introduce excessive oil into the air delivery system and produce greater demands on the filtering or conditioning units. Overall maintenance of the compressor and regular draining of receivers is essential in avoiding oil accumulation.

As the compressor produces hot air, the refrigerant dryer cools the compressed air and condenses much of the moisture for easy removal. This prepares the air for further treatment.

A storage tank is necessary to maintain a constant supply of compressed air as needed. The tank should be sized to meet the demands of the shop.

In regards to an air compressor as the source of breathing air, an excerpt from The Federal Code of Regulations. Title 29 CFR part 1910.134 (i) (1) (ii) air quality specification states; "Compressed breathing air shall meet at least the requirements for Grade D breathing air described in ANSI/Compressed Gas Association commodity specification G-7.1-1989, to include:

- (A) Oxygen content (v/v) of 19.5 - 23.5%;
- (B) Hydrocarbon (condensed) content of 5 milligrams per cubic meter of air or less;
- (C) Carbon Monoxide (CO) content of 10 ppm or less;
- (D) Carbon Dioxide content of 1000 ppm or less; and
- (E) Lack of noticeable odor. In addition, Title 29 CFR Labor part 1910.134 (i)

(6), For compressors that are not oil lubricated, the employer shall ensure that carbon monoxide levels in the breathing air do not exceed 10 ppm. (7); "For oil lubricated compressors, the employer shall use a high-temperature or carbon monoxide alarm, or both. If only a high-temperature alarm is used, the air from the compressor shall be frequently tested to monitor carbon monoxide levels..."

(Full documentation is available at www.osha.gov)

Often pipes may be a long distance from the compressor to the delivery point. Pipes of adequate diameter and proper material to avoid pressure loss and contamination of the air stream are required. The most common material in use is black iron pipe. With proper design, filtering and monitoring, it is fully acceptable. Thermo-plastic pipes should never be used because the material might out-gas in the event of high ambient temperatures. "Out-gassing" is a term meaning the release of toxic gases as air flows over the material used in the manufacturing process. The size of pipe and over-all system design for a major installation would exceed the scope of this review. However, Pipes must be carefully sized, looped and arranged to minimize pressure drop and should be sloped to drain towards a drop leg or moisture trap. See figure below for a general overview and correct method of installation. The objective is to plan a delivery system that will avoid pressure loss due to unnecessary flow restriction with a reasonable size of plumbing and deal with the accumulation of oil, scale and water.

BODY SHOP AIR PIPING LAYOUT

Shop layout line filter and point of use regulators

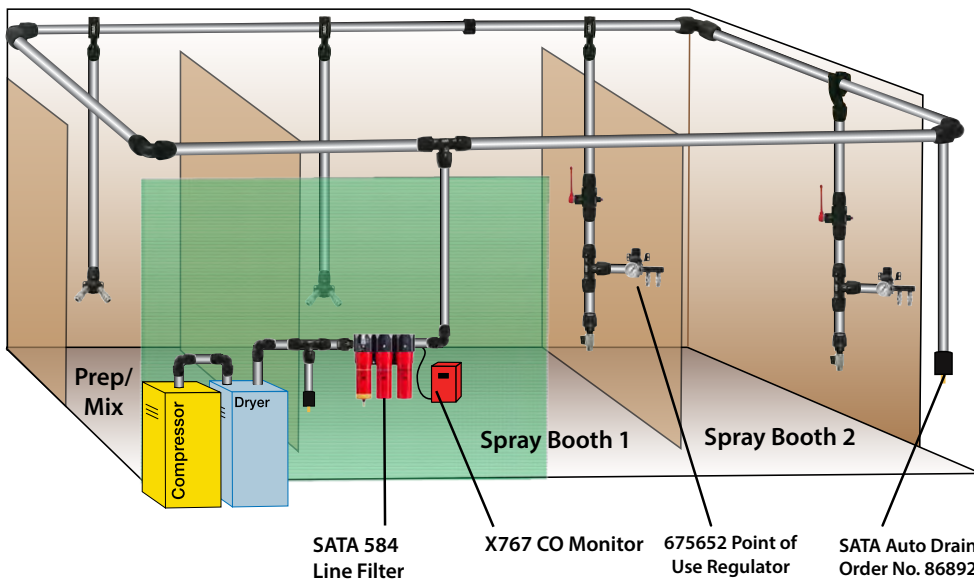

Auto drain discharge must be located outside paint area

General Rules For Compressed Air Distribution:

1. Pressure drop between the compressor and point of use is irrecoverable.
2. Pipe size should be large enough that pressure drop doesn't exceed 10% between receiver and point of use.
3. Arrange piping to avoid strains.
4. Locate air compressor to draw clean uncontaminated air from the atmosphere.
5. Drain air compressor and drain legs in the a.m.
6. Plan ahead for future emergencies and establish an area of loop to install temporary compressor.
7. Consider by-pass lines on all items that may require future maintenance.
8. Use loop piping system if possible, both around the plant and within each shop. Loop piping has 1/2 the pressure drop than that of a straight run for the same overall length of pipe
9. Consider second air receiver at end of line or loop if you have peak demands for air of short durations.
10. Locate outlets from the main header as close as possible to the point of application. This limits pressure drops.
11. Outlets must always be taken from the top of the pipe line to prevent carryover of condensed moisture to tools.
12. All piping should slope so that it drains towards a drop leg or moisture trap - away from compressor.
13. To help avoid frequent filter changes, the first outlet should be far enough away from the compressor to allow the air to cool (condense) when a refrigerated dryer is not used.
14. The main air line stand pipe should not be smaller than the compressor outlet size.

Worker Health Protection & Accessories

SATA Male Nipple BSP

1/4" male BSP

Order No. 53942



SATA Female Nipple BSP

1/4" female BSP

Order No. 13656



SATA Male Quick Coupling

1/4" male BSP

Order No. 13623



SATA Female Quick Coupling

1/4" female BSP

Order No. 13599



SATA® air check set

Compressed air testing device for perfect quality.

Order No. 7096



Replacement Kits



Service Kit SATA 200 & 400 filter

Charcoal cartridge, 85373 4 pk, Fine filter cartridge, 81810, 2 pk

Order No. 214270 SAVES

Service Kit for SATA 500 filter

with fine filter and activated charcoal cartridge

Order No. 1098054

SAVE \$81.00

All SATA filter cartridges are supplied with a SATA filter timer



Replacement Filter

Activated Charcoal Filter.

Replacement cartridge for the SATA vision 2000 charcoal filter belt unit.

Order No. 13904



Dan-Am in-line regulator

Precise control of air flow and pressure with a 160 psi gauge, 1/2"

Order No. 675635



Dan-Am in-line regulator w/bracket

Precise control of air flow and pressure with a 160 psi gauge, bracket, 1/2"

Order No. 675634



Dan-Am point of use regulator

with two or four drop manifold, mounting bracket

Max inlet pressure: 216 psi

Max. cfm: 140

Two drop manifold

Order No. 675652

Four drop manifold

Order No. 675654



S*A*M*S* - Supplied Air Monitoring System

A COMPLETE SUPPLIED AIR RESPIRATOR SYSTEM INCLUDING COMPRESSED AIR WALL FILTER, REGULATOR, CO MONITOR, HOSE, AND FITTINGS

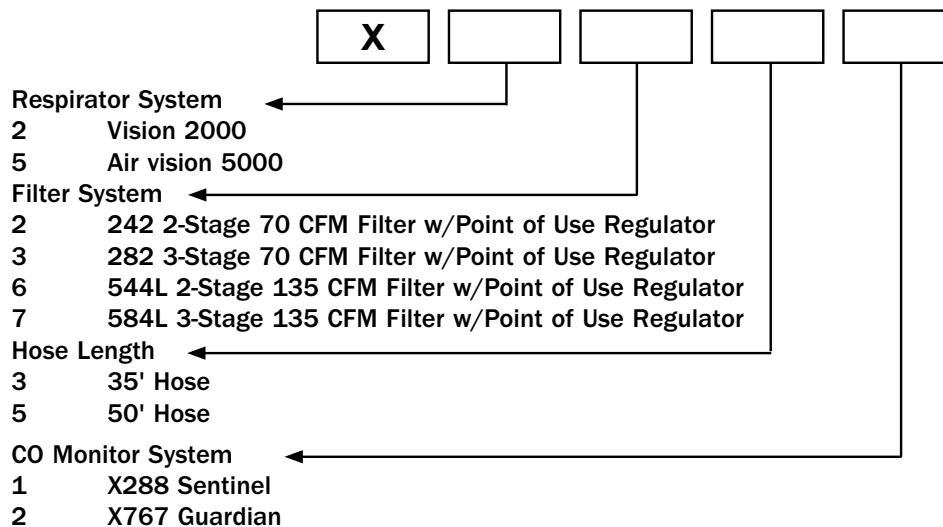

Example

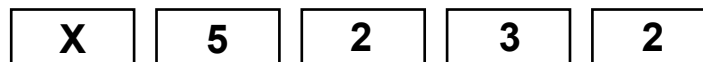

This part number includes:

- 1 - Air vision 5000 Hood with Belt Unit
- 1 - 2-Stage Line Filter and Regulator with 2 Connections
- 1 - 35' Hose
- 1 - X767 CO Monitor

Systems include necessary fittings and Loctite for complete installation



Tips: Choose the 2 stage filter for solvent based coatings
Choose the 3 stage filter for water based coatings

Worker Health Protection & Accessories

Premo Flex Red Breathing Hose

Top quality breathing hose for breathing air and air tools.



- Hose Assembly**, 3/8 ID, 250 psi hose w/coupler & nipple. NIOSH approved
- 676010 Premium Breathing Hose 10'
 - 676015 Premium Breathing Hose 15'
 - 676020 Premium Breathing Hose 20'
 - 676025 Premium Breathing Hose, 25'
 - 676035 Premium Breathing Hose, 35'
 - 676050 Premium Breathing Hose, 50'
 - 676075 Premium Breathing Hose, 75'
 - 676100 Premium Breathing Hose, 100'

Hose Assembly, 3/8 ID, 250 psi hose w/ coupler and 1/4" male fitting. NIOSH approved for **Vision 2000 and Air star C**.

- 3366 Premium Breathing Hose, 25'
- 4635 Premium Breathing Hose, 35'
- 6633 Premium Breathing Hose, 50'

while supplies last

SATA wet/dry cleaner

Wet cloth removes contamination, wipe mask with dry cloth for instant use

- 10 pk **Part no. 75358**
- 50 pk **Part no. 83881**



PRO-SERIES Paint Suits

Expertly designed for fit and movement. Made with the finest quality anti-static carbon fiber thread to keep it lint free. Comes white on front with logo and grey back with the SATA logo. The hooded suit has a covered heavy duty zipper, exterior utility Velcro pocket, adjustable sleeve and leg Velcro closures, wide leg, adjustable elastic waist band for comfort, fully breathable back fabric, 2 utility back pockets, underarm zipper opening for ventilation when needed, bi-swing shoulders for easier movements. Lengthened side zipper, lighter weight protective fabric in the hood. Outperforms and outlasts disposables at least 10 to 1. The paint suits are machine washable and available in sizes small to 3XL.



Pro-Series Suit

Pro Series Paint Suit	
510050PS	X-Small
510052PS	Small
510054PS	Medium
510056PS	Large
510058PS	XLarge
510060PS	XXLg (2XL)
510062PS	XXXLg (3XL)

GBG PRO-SERIES Ladies Paint Suits

It has all the features of the Pro Series suit, including being anti-static. Plus it has the added features: pocket knee pads, colored ankle and wrist closures, detailed piping, the Girls Behind the Gun and Goddess Behind the Gun logos.



Pro-Series Ladies Suit

Pro Series Ladies Paint Suit	
540050GBG	X-Small
540052GBG	Small
540054GBG	Medium
540056GBG	Large
540058GBG	XLarge
540060GBG	XXLg (2XL)
540062GBG	XXXLg (3XL)

Paint Suits

SATA USA Inc offers high-quality paint suits. Two with the SATA logo on the front and back. They are made of 100% breathable nylon that offers superior protection over clothing. These paint suits are treated to be anti-static, open at the wrist, ankle and face. It features a hood to cover the head and has an elastic waist band. This helps avoid brushing into the paint job. The arm cuffs are also adjustable.



Grey Paint Suit

Grey Paint Suit	
520050G	X-Small
520052G	Small
520054G	Medium
520056G	Large
520058G	XLarge
520060G	XXLg (2XL)
520062G	XXXLg (3XL)
520064G	XXXXLg (4XL)



White Paint Suit

White Paint Suit	
530050W	X-Small
530052W	Small
530054W	Medium
530056W	Large
530058W	XLarge
530060W	XXLg (2XL)
530062W	XXXLg (3XL)
530064W	XXXXLg (4XL)

Your SATA dealer



SATA USA Inc.

One Sata Drive · PO Box 46
Spring Valley, MN 55975
Phone: 800-533-8016
E-mail: satajet@satausa.com
www.satausa.com

42_Clean Air
Printed in U.S.A.
24-0301

Errors and technical alterations reserved - SATA, SATAjet and/or other SATA products referenced herein are either registered trademarks or trademarks of SATA GmbH & Co. KG in the U.S. and/or other countries.